



WWW.ROZAGRAPISA.COM

comercial@rozagrapi.com

San Vicente Mártir, 20
Ana María, 47

28043 MADRID
33209 GIJÓN

Tif +34 914166614 / +34 914167626 Fax +34 915193075
Tif +34 985162833 Fax +34 985146622

Catalogo Compressori / Compressors Catalogue



COMPRESSORI / AIR-COMPRESSORS

COMPRESSORI PROFESSIONALI A SECCO
HEAVY-DUTY OIL-LESS AIR COMPRESSORS pg 13-18

COMPRESSORI PROFESSIONALI SILENZIATI
HEAVY-DUTY SILENCED COMPRESSORS pg 19-22

ACCESSORI PER COMPRESSORI
AIR COMPRESSORS ACCESSORIES pg 23-27

GRUPPI POMPANTI / AIR PUMPS

PROFESSIONALI A SECCO
OIL-FREE, HEAVY-DUTY pg 31-34

PROFESSIONALI A SECCO SILENZIATI
OIL-FREE HEAVY-DUTY SILENCED pg 35-38



COMPRESSORI
AIR-COMPRESSORS

► I NOSTRI COMPRESSORI UNICI OUR UNIQUE AIR COMPRESSOR

Durante le normali operazioni di lavoro quotidiane, IT quali in ambienti come officine, laboratori, o cantieri, ma anche studi dentistici/medicali è essenziale non avere complicazioni relative al funzionamento dell'attrezzatura, poichè, se non è possibile concentrarsi completamente sulla propria attività, le ripercussioni negative vengono rapidamente rilevate in termini di qualità, tempistiche e costi, elementi importantissimi nel mercato competitivo di oggi, e per distinguersi dalla concorrenza.

Gentilin vuole quindi soffermarsi e fare un pò di informazione in un settore sempre più vasto e articolato, dove si rischia di perdersi tra le opzioni disponibili e le molteplici diversità. Perché la scelta di un compressore va ben oltre ai dati che si presentano sulla carta.

During the normal course of daily work, EN in areas such as workshops, labs, construction sites, but in dental/medical offices as well, it is very important not to have equipment stoppages. After all, when it is not possible to provide undivided attention to the job, negative repercussions become rapidly obvious in terms of quality, timeliness and costs, all of which are extremely important elements in today's competitive markets, and crucial for differentiation with other market players.

Therefore, Gentilin would like to pause and expand on the information in a market segment that is increasingly large and varied, where the risk is to get lost in vastness of options. The choice of the right compressor – in other words – goes well beyond the technical data seen on paper.



► TABELLA COMPARATIVA COMPARISON CHART

IT

	COASSIALI A SECCO	COASSIALI LUBRIFICATI	A CINGHIA LUBRIFICATI	GENTILIN A SECCO
Caratteristiche				
Applicazioni/Categoria	Hobbistica	semi-professionali	professionali/ uso intensivo	professionali uso intensivo
Classe motore	S3	S3	S1 / S3	S1
RPM	1400/2800	1400/2800	1200/1700	1400
Meccanica	pistone basculante	pistone basculante/ articolato	pistone articolato	doppio pistone in asse (brevettato)
Lubrificazione	X	Olio	Olio	X
Prestazioni				
Rendimento/Efficienza	55%	60%	65%	65%
Pressione massima	8	10	10/12	10,5
Ciclo di utilizzo	50-60% ON	50-60% ON	50-70% ON	100% ON - 24/24h utilizzo in continuo
Vita totale	breve termine	medio termine	lungo termine	lungo termine
Intervalli di manutenzione				
Cambio olio	Non necessario	100 ore	150 ore	Non necessario
Fissaggio/cambio cinghia	Non necessario	Non necessario	2000 ore	Non necessario
Cambio guarnizioni	800 ore	1500 ore	1500 ore	5000 ore

EN

	OIL-FREE COAXIAL	LUBRICATED COAXIAL	LUBRICATED BELT-DRIVE	GENTILIN OIL-FREE
Characteristics				
Application fields	light-duty	semi-professional	professional/heavy-duty	professional/heavy-duty
Motor Class	S3	S3	S1 / S3	S1
RPM	1400/2800	1400/2800	1200/1700	1400
Mechanical system	wobble piston	wobble/articulate piston	articulate piston	patented axial piston
Lubrication	X	Oil	Oil	X
Performance				
Intake/5-bar-outlet rapport	55%	60%	65%	65%
Max pressure	8	10	10/12	10,5
Duty cycle	50-60% ON	50-60% ON	50-70% ON	100% ON - 24/24h continuous usage
Expected life span	short	medium	long	long
Maintenance overhaul time				
Oil Change	No need	100 hours	150 hours	No need
Belt strength/Replacement	No need	No need	2000 hours	No need
Gaskets and rings change	800 hours	1500 hours	1500 hours	5000 hours



I compressori GENTILIN:

IT

- **Tecnologia innovativa (3-4)**

I compressori coassiali a secco GENTILIN stravolgono le tradizionali categorie sopracitate introducendo nel mercato l'innovativo e brevettato sistema meccanico del DOPPIO PISTONE IN ASSE. Questa innovativa soluzione meccanica permette ai compressori coassiali a secco GENTILIN di mantenere le vantaggiose caratteristiche di ognuna delle tre categorie descritte sopra, eliminandone gli aspetti negativi.

Il doppio pistone dei compressori a secco Gentilin, dotati del brevetto esclusivo Gentilin Air Compressors, scorre assialmente all'interno di speciali cilindri in alluminio dotati di rivestimento ceramico, riducendo drasticamente l'usura delle guarnizioni. Questa innovativa soluzione meccanica garantisce bassi carichi di stress per il motore, flusso poten-



(3)

GENTILIN compressors:

EN

- **Innovative technology (3-4)**

GENTILIN-branded oil-free, coaxial compressors have revolutionized the above-mentioned categories, having introduced an innovative and patented mechanical system of DOUBLE PISTON sliding along a SINGLE AXIS. This groundbreaking mechanical solution makes it possible for these compressors to keep the favorable characteristics of the other categories of compressors, while at the same time eliminating their negative aspects.

The double piston of GENTILIN oil-free compressors have an exclusive patent design: it slides axially inside ceramic-coated cylinders, which results in a drastic reduction in the wear of the oil rings. This cutting edge mechanical solution guarantees low load on the motor, a powerful and constant

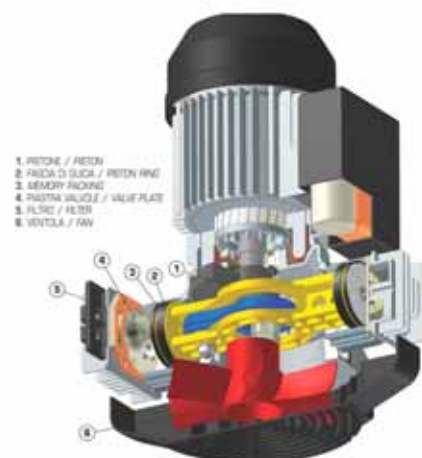

(4)

te e costante all'aumentare della pressione e partenze a bassi voltaggi grazie alla maggiore efficienza e stabilità dell'intero organo pompante.

L'insieme di queste caratteristiche fa dei compressori coassiali a secco Gentilin prodotti unici nel mercato. Potenti, compatti e portatili, dal flusso d'aria pulito e adatti all'uso intensivo senza bisogno di frequenti e costose manutenzioni.

- **Design orientato all'uso**

Il design dei compressori Gentilin è stato progettato tenendo in considerazione principalmente le esigenze di lavoro dell'utente, che frequentemente si può trovare a svolgere la propria attività in condizioni ostiche e non ottimali. La facilità di trasporto/movimentazione e di utilizzo dell'attrezzatura è per GENTILIN un punto fondamentale per lo sviluppo dei prodotti.

- **Affidabilità garantita**

In aggiunta alla minuziosa selezione dei materiali e l'utilizzo esclusivo di motori sviluppati specificatamente per i compressori Gentilin, l'azienda ha scelto di produrre, assemblare, e collaudare l'intera gamma di compressori in Italia, garantendone la più alta qualità durante ogni fase di sviluppo e produzione sia dei componenti che del prodotto finito.

I compressori coassiali a secco GENTILIN sono prodotti destinati al mercato professionale, garantiscono l'utilizzo di utensili ad aria ad alto consumo, unendo assoluta affidabilità alla più alta efficienza prestazionale.

La tecnologia integrata nei compressori a secco Gentilin permette di ottenere le più alte prestazioni nello svolgimento di operazioni come verniciatura, sabbatura, fissaggio, riparazioni, carpenteria, ecc, oltre che superare le problematiche legate alla manutenzione della strumentazione, lasciando all'utente la libertà di concentrare le proprie risorse umane ed economiche sul lavoro in corso.

air flow at increasing pressures, and start-ups at low voltages – all this thanks to greater efficiency within the internal pumping mechanism.

These features make a GENTILIN-branded, oil-free coaxial compressor one-of-a-kind. Powerful, compact, portable, clean air flow and suitable for continuous use without frequent and costly maintenance.

- **Application-oriented use**

The design of Gentilin compressors has been conceptualized keeping in mind principally the work requirements of the user. Frequently, work conditions can be difficult and less than optimal. The ease in which these compressors can be moved and transported is a fundamental product development feature for GENTILIN.

- **Guaranteed reliability**

In addition to the painstaking selection of materials and the use of motors that were exclusively designed for Gentilin, the company has decided to manufacture, assemble, and pilot test in Italy the entire line of compressors. This decision guarantees a higher quality at each phase of development and production, both for individual components as well as the final product.

Oil-free, coaxial Gentilin compressors are suitable for products that fall in the professional category and that use high-consumption air tools. A perfect blend of absolute reliability and high performance efficiency.

The integrated technology in Gentilin's oil-free compressors permits very demanding performances in applications such as painting, sandblasting, fastening, repairs, wood-working, etc. In addition, it frees the user from having to be concerned about maintenance, and instead concentrate on optimizing human and economic resources.

► **COMPRESSORI PROFESSIONALI A SECCO**
HEAVY-DUTY OIL-LESS AIR COMPRESSORS



Caratteristiche

IT

- Senza Olio
- Senza Manutenzione
- Massima portabilità
- Classe di utilizzo S1 lavoro in continuo
- Bassi giri motore
- Made in Italy

Characteristics

EN

- Oil-less
- Maintenance free
- Maximum portability
- Class of utilization S1 continuous work
- Low RPM
- Made in Italy

Carrellati Custom / Custom on trolleys

B110/05 - ARIOSTO

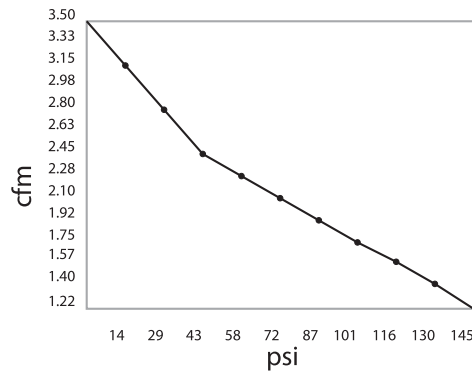
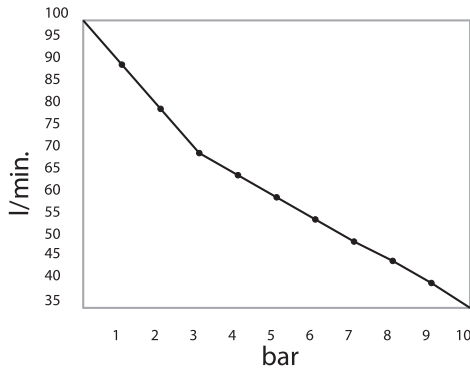

Modello	Potenza		Tensione	Giri	Serbatoio		Cilindri	Pressione max		Aria aspirata		Aria resa (5 bar)		Rumore	Misure	Peso	
Model	Power		Voltage	RPM	Tank		Cylinders	Max pressure		Air intake		Air yield		Noise	Dimensions	Weight	
	Kw	Hp	V/Hz/Va	rpm	Lt	Gal	n°	Bar	Psi	L/min	C.F.M.	L/min	C.F.M.	dB (A)	(LxHxW) cm	Kg	Lbs
B110/05	0,45	0,75	230/50	2800	5	1,32	1	10	130,5	110	3,9	60	2,3	72	42x39x19	10,5	23,15

Carrellati Custom / Custom on trolleys

C330/03

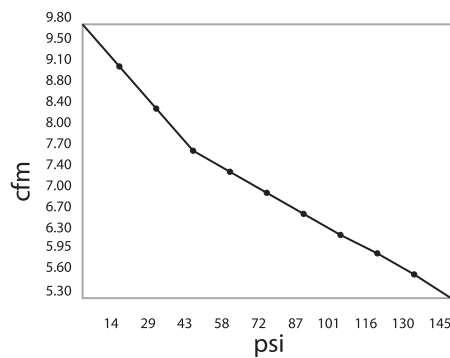
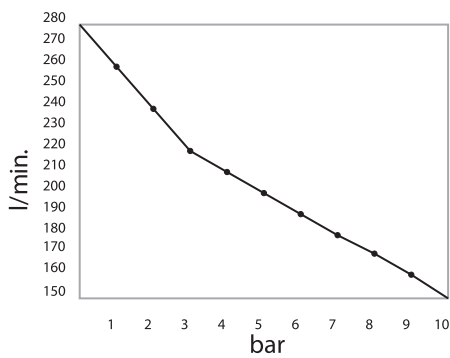

Modello	Potenza		Tensione	Giri	Serbatoio		Cilindri	Pressione max		Aria aspirata		Aria resa (5 bar)		Rumore	Misure	Peso	
Model	Power		Voltage	RPM	Tank		Cylinders	Max pressure		Air intake		Air yield		Noise	Dimensions	Weight	
	Kw	Hp	V/Hz/Va	rpm	Lt	Gal	n°	Bar	Psi	L/min	C.F.M.	L/min	C.F.M.	dB (A)	(LxHxW) cm	Kg	Lbs
C330/03	1,7	2,5	230/50	1400	3	0,79	2	10	145	330	11,7	200	7	80	49x57x42	32	70,5

100% DUTY CYCLE

Carrellati Custom / Custom on trolleys

C330/10

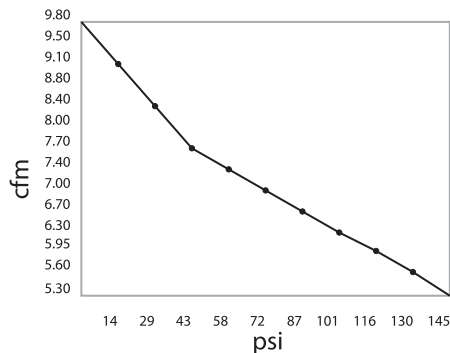
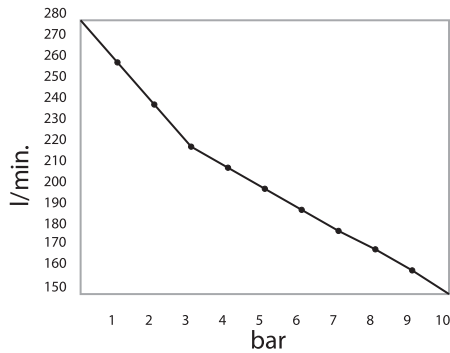

Modello	Potenza		Tensione	Giri	Serbatoio		Cilindri	Pressione max		Aria aspirata (5 bar)		Aria aspirata	Rumore	Misure	Peso		
Model	Power		Voltage	RPM	Tank		Cylinders	Max pressure		Air intake		Air yield	Noise	Dimensions	Weight		
	Kw	Hp	V/Hz/Va	rpm	Lt	Gal	n°	Bar	Psi	L/min	C.F.M.	L/min	C.F.M.	dB (A)	(LxHxW) cm	Kg	Lbs
C330/10	1,7	2,5	230/50	1400	5+5	1,3+1,3	2	10	145	330	11,7	200	7	80	40x78x45	36	79,3

100% DUTY CYCLE

Carrellati Custom / Custom on trolleys

C330/20

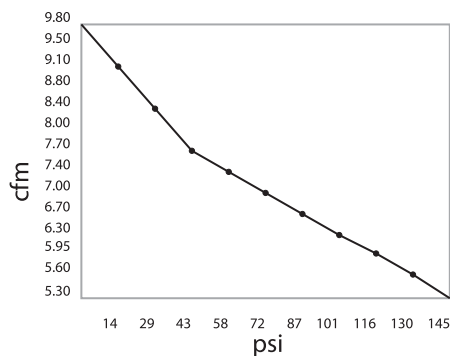
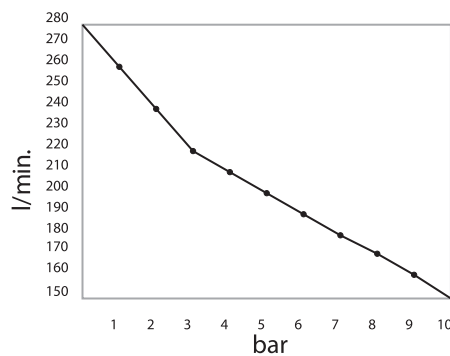

Modello	Potenza		Tensione	Giri	Serbatoio		Cilindri	Pressione max		Aria aspirata		Aria resa (5 bar)	Rumore	Misure	Peso		
Model	Power		Voltage	RPM	Tank		Cylinders	Max pressure		Air intake		Air yield	Noise	Dimensions	Weight		
	Kw	Hp	V/Hz/Va	rpm	Lt	Gal	n°	Bar	Psi	L/min	C.F.M.	L/min	C.F.M.	dB (A)	(LxHxW) cm	Kg	Lbs
C330/20	1,7	2,5	230/50	1400	10+10	2,6+2,6	2	10	145	330	11,7	200	7	80	56x52x66	43	94,8

100% DUTY CYCLE

Carrellati Custom / Custom on trolleys

C330/24

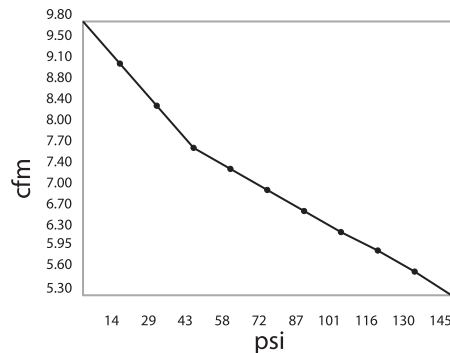
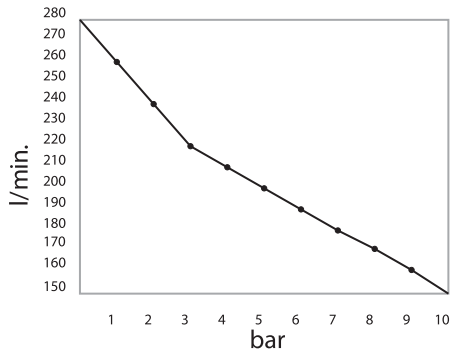

Modello	Potenza		Tensione	Giri	Serbatoio		Cilindri	Pressione max		Aria aspirata		Aria resa (5 bar)		Rumore	Misure	Peso	
Model	Power		Voltage	RPM	Tank		Cylinders	Max pressure		Air intake		Air yield		Noise	Dimensions	Weight	
	Kw	Hp	V/Hz/Va	rpm	Lt	Gal	n°	Bar	Psi	L/min	C.F.M.	L/min	C.F.M.	dB (A)	(LxHxW) cm	Kg	Lbs
C330/24	1,7	2,5	230/50	1400	24	6,34	2	10	145	330	11,7	200	7,06	80	50x81x56	36	79,37
100% DUTY CYCLE																	

Carrellati Custom / Custom on trolleys

C330/50

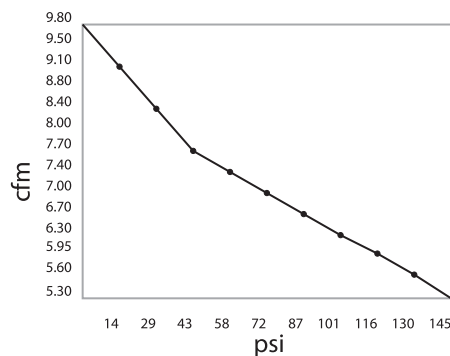
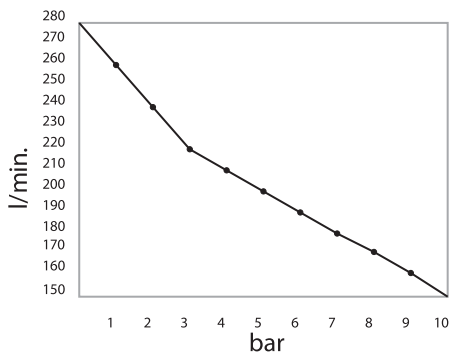

Modello	Potenza		Tensione	Giri	Serbatoio		Cilindri	Pressione max		Aria aspirata		Aria resa (5 bar)		Rumore	Misure	Peso	
Model	Power		Voltage	RPM	Tank		Cylinders	Max pressure		Air intake		Air yield		Noise	Dimensions	Weight	
	Kw	Hp	V/Hz/Va	rpm	Lt	Gal	n°	Bar	Psi	L/min	C.F.M.	L/min	C.F.M.	dB (A)	(LxHxW) cm	Kg	Lbs
C330/50	1,7	2,5	230/50	1400	50	13,21	2	10	145	330	11,7	200	7,06	80	50x103x56	44	97
100% DUTY CYCLE																	

Carrellati Standard / Standard on trolleys

C330/100 - C330/150

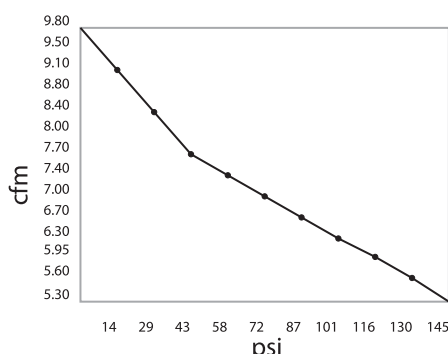
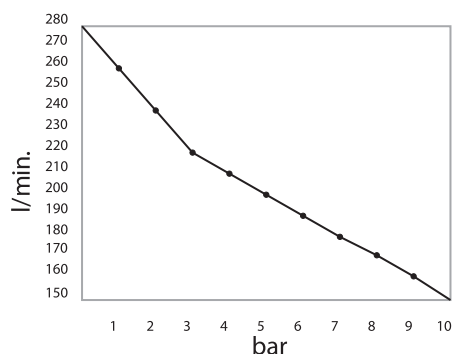

Modello	Potenza		Tensione	Giri	Serbatoio		Cilindri	Pressione max		Aria aspirata		Aria resa (5 bar)	Rumore	Misure	Peso		
Model	Power		Voltage	RPM	Tank		Cylinders	Max pressure		Air intake		Air yield	Noise	Dimen-sions	Weight		
	Kw	Hp	V/Hz/Va	rpm	Lt	Gal	n°	Bar	Psi	L/min	C.F.M.	L/min	C.F.M.	dB (A)	(LxHxW) cm	Kg	Lbs
C330/100	1,7	2,5	230/50	1400	100	26,42	2	10	145	330	11,7	200	7,06	80	40x70x115	64	141,1
C330/150	1,7	2,5	230/50	1400	150	39,63	2	10	145	330	11,7	200	7,06	80	45x85x120	84	185

100% DUTY CYCLE

Carrellati Standard / Standard on trolleys

C660/100

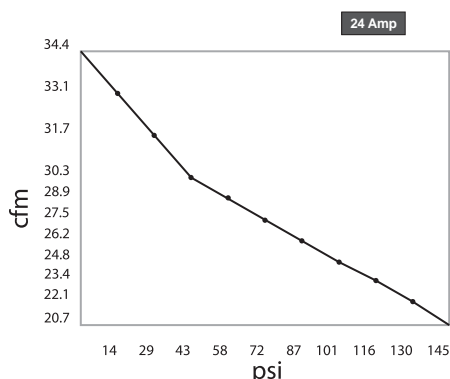
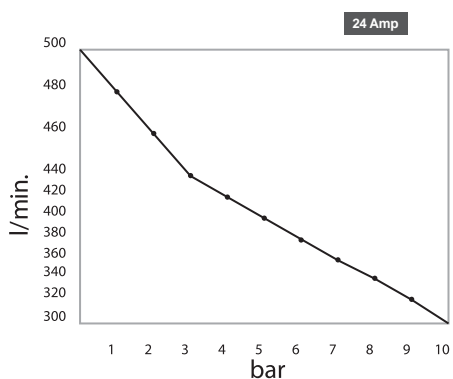

Modello	Potenza		Tensione	Giri	Serbatoio		Cilindri	Pressione max		Aria aspirata		Aria resa (5 bar)	Rumore	Misure	Peso		
Model	Power		Voltage	RPM	Tank		Cylinders	Max pressure		Air intake		Air yield	Noise	Dimen-sions	Weight		
	Kw	Hp	V/Hz/Va	rpm	Lt	Gal	n°	Bar	Psi	L/min	C.F.M.	L/min	C.F.M.	dB (A)	(LxHxW) cm	Kg	Lbs
C660/100	1,7+1,7	2,5+2,5	230/50	1400	100	26,42	2+2	10	145	660	23,31	400	14,13	85	40x70x115	88	194

Monofase - Single-phase

100% DUTY CYCLE

Carrellati Standard / Standard on trolleys E480/100

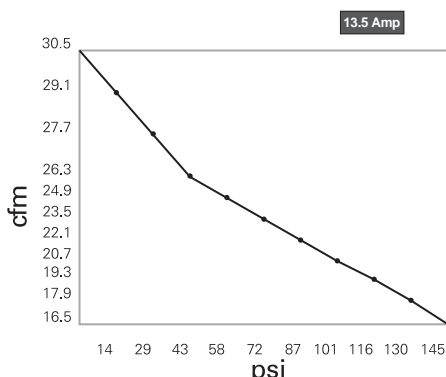
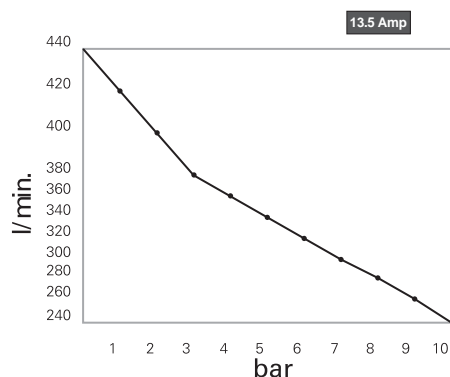

Modello	Potenza		Tensione	Giri	Serbatoio		Cilindri	Pressione max		Aria aspirata		Aria resa (5 bar)	Rumore	Misure	Peso		
Model	Power		Voltage	RPM	Tank		Cylinders	Max pressure		Air intake		Air yield	Noise	Dimensions	Weight		
	Kw	Hp	V/Hz/Va	rpm	Lt	Gal	n°	Bar	Psi	L/min	C.F.M.	L/min	C.F.M.	dB (A)	(LxHxW) cm	Kg	Lbs
E480/100	3,2	4	230/50	1400	100	26,42	4	10	145	480	16,95	340	12,01	80	40x70x115	83	182,9
Monofase - Single-phase															100% DUTY CYCLE		

Carrellati Standard / Standard on trolleys E660/100 - E660/200 - E660/270

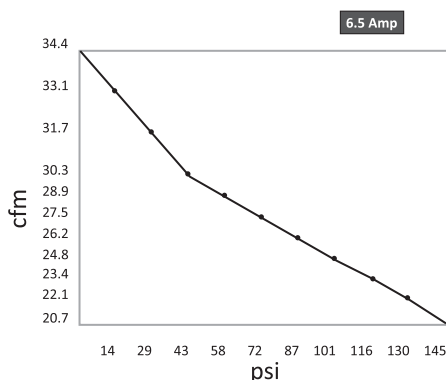
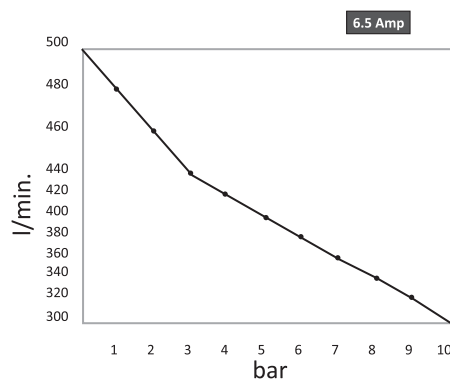

Modello	Potenza		Tensione	Giri	Serbatoio		Cilindri	Pressione max		Aria aspirata		Aria resa (5 bar)	Rumore	Misure	Peso		
Model	Power		Voltage	RPM	Tank		Cylinders	Max pressure		Air intake		Air yield	Noise	Dimensions	Weight		
	Kw	Hp	V/Hz/Va	rpm	Lt	Gal	n°	Bar	Psi	L/min	C.F.M.	L/min	C.F.M.	dB (A)	(LxHxW) cm	Kg	Lbs
E660/100	3,4	4,5	380/50	1400	100	26,42	4	10	145	660	23,31	400	14,13	85	40x70x115	85	187,4
E660/200	3,4	4,5	380/50	1400	200	52,83	4	10	145	660	23,31	400	14,13	85	55x85x125	125	275
E660/270	3,4	4,5	380/50	1400	270	71,33	4	10	145	660	23,31	400	14,13	85	60x90x130	155	340
Trifase - Three-phase															100% DUTY CYCLE		

► **COMPRESSORI PROFESSIONALI SILENZIATI**
HEAVY-DUTY SILENCED COMPRESSORS



Caratteristiche

IT

- Silenziati (67db)
- Senza Olio
- Senza Manutenzione
- Massima portabilità
- Classe di utilizzo S1 lavoro in continuo
- Bassi giri motore
- Made in Italy

Characteristics

EN

- Silenced (67db)
- Oil-less
- Maintenance free
- Maximum portability
- Class of utilization S1 continuous work
- Low RPM
- Made in Italy

Le soluzioni tecniche adottate:
Technical solutions:

1

Il peculiare sistema a canali interni riduce drasticamente il rumore di aspirazione.

A unique system of internal intake air grooves drastically reduces noise.

+

2

Piastre a valvola gemellate, deviano il flusso d'aria in ingresso, permettendo un'eccellente abbattimento acustico.

Twin valve plates with advanced vibration-dampening characteristics absorb and isolate turbulent humming.



+

3

L'isolamento del sistema meccanico tramite chiusura ad alta precisione, blocca la fuoriuscita del rumore generato dai corpi in movimento.

Entire mechanism is insulated through a high-precision plate that prevents leakage of noises generated by moving parts.

+

4

Gli anti-vibranti in gomma posizionati tra pompa e serbatoio, isolano il sistema pompante eliminando la trasmissione di vibrazioni al serbatoio.

Exceptional vibration reduction through rubber pads mounted between pump and tank.

**= 67 dB**

Silenziati Custom / Custom Silenced

CS240/03

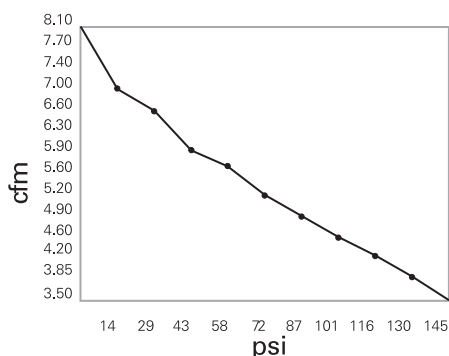
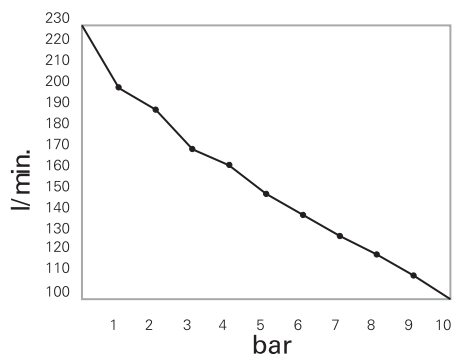

Modello	Potenza		Tensione	Giri	Serbatoio		Cilindri	Pressione max		Aria aspirata		Aria resa (5 bar)		Rumore	Misure	Peso	
Model	Power		Voltage	RPM	Tank		Cylinders	Max pressure		Air intake		Air yield		Noise	Dimensions	Weight	
	Kw	Hp	V/Hz/Va	rpm	Lt	Gal	n°	Bar	Psi	L/min	C.F.M.	L/min	C.F.M.	dB (A)	(LxHxW) cm	Kg	Lbs
CS240/03	1,5	2	230/50	1400	3	0,79	2	10	145	240	8,48	150	5,3	67	49x57x42	30	66
Su richiesta sono disponibili diversi voltaggi - Different voltage available on request														110v/60Hz - 110v/50Hz - 230v/60Hz		100% DUTY CYCLE	

Silenziati Custom / Custom Silenced

CS240/10

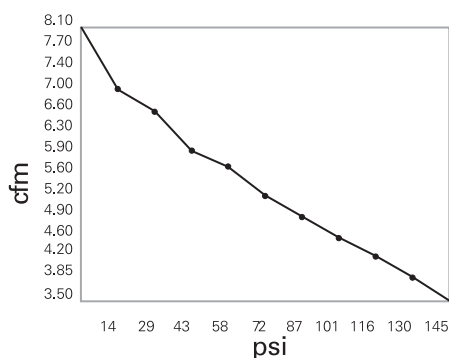
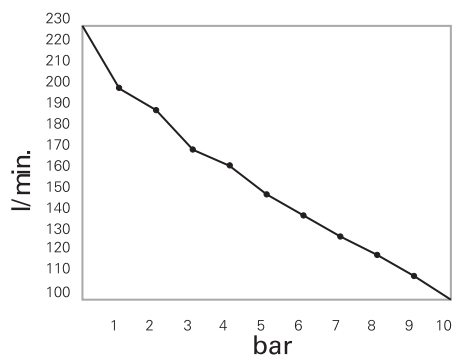

Modello	Potenza		Tensione	Giri	Serbatoio		Cilindri	Pressione max		Aria aspirata		Aria resa (5 bar)		Rumore	Misure	Peso	
Model	Power		Voltage	RPM	Tank		Cylinders	Max pressure		Air intake		Air yield		Noise	Dimensions	Weight	
	Kw	Hp	V/Hz/Va	rpm	Lt	Gal	n°	Bar	Psi	L/min	C.F.M.	L/min	C.F.M.	dB (A)	(LxHxW) cm	Kg	Lbs
CS240/10	1,5	2	230/50	1400	5+5	1,3+1,3	2	10	145	240	8,48	150	5,3	67	40x78x45	34	74
Su richiesta sono disponibili diversi voltaggi - Different voltage available on request														110v/60Hz - 110v/50Hz - 230v/60Hz		100% DUTY CYCLE	

Silenziati Custom / Custom Silenced

CS240/24

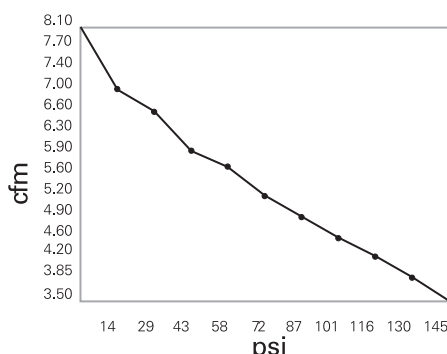
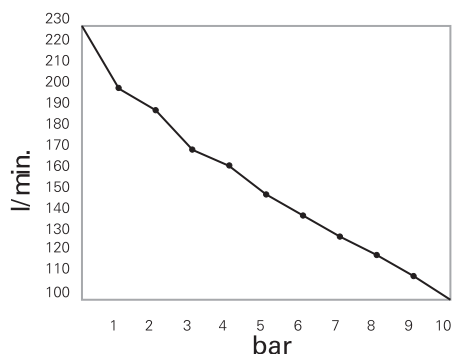

Modello	Potenza		Tensione	Giri	Serbatoio		Cilindri	Pressione max		Aria aspirata		Aria resa (5 bar)	Rumore	Misure	Peso		
Model	Power		Voltage	RPM	Tank		Cylinders	Max pressure		Air intake		Air yield	Noise	Dimensions	Weight		
	Kw	Hp	V/Hz/Va	rpm	Lt	Gal	n°	Bar	Psi	L/min	C.F.M.	L/min	C.F.M.	dB (A)	(LxHxW) cm	Kg	Lbs
CS240/24	1,5	2	230/50	1400	24	6,34	2	10	145	240	8,48	150	5,3	67	50x81x56	34	74,96
Su richiesta sono disponibili diversi voltaggi - Different voltage available on request													110v/60Hz - 110v/50Hz - 230v/60Hz		100% DUTY CYCLE		

Silenziati Custom / Custom Silenced

ES480/100

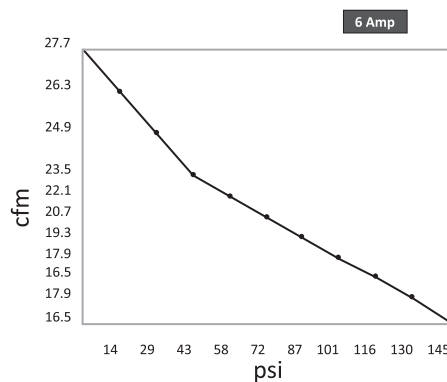
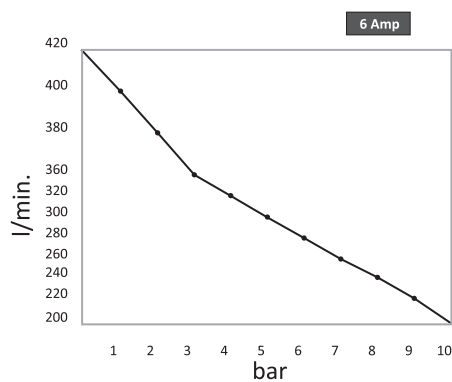

Modello	Potenza		Tensione	Giri	Serbatoio		Cilindri	Pressione max		Aria aspirata		Aria resa (5 bar)	Rumore	Misure	Peso		
Model	Power		Voltage	RPM	Tank		Cylinders	Max pressure		Air intake		Air yield	Noise	Dimensions	Weight		
	Kw	Hp	V/Hz/Va	rpm	Lt	Gal	n°	Bar	Psi	L/min	C.F.M.	L/min	C.F.M.	dB (A)	(LxHxW) cm	Kg	Lbs
ES480/100	3,4	4,5	380/50	1400	100	26,42	4	10	145	480	16,95	300	10,59	69	40x70x120	85	187,4
Trifase - Three-phase													100% DUTY CYCLE				

▶ **ACCESSORI PER COMPRESSORI**
AIR COMPRESSORS ACCESSORIES



Valvole / Air valves



Cod. 83026/1 Valvola di non ritorno / Non return valve

- 1= 3/8 M
- 2= 3/8 M
- 3= 6 mm

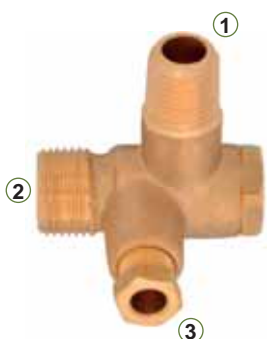

Cod. 83026/2 Valvola di non ritorno / Non return valve

- 1= 1/4 M
- 2= 3/8 M
- 3= 6 mm



Cod. 82098 Valvola di sicurezza / Safety valve

- 1/4 M
- 11 bar

Ruote / Wheels



Cod. 83032 Ruota in gomma solida / Solid rubber wheel

IT Dimensioni ruota: 160x35mm
Diametro foro: 20mm

EN Wheel dimension: 160x35mm
Hole diameter: 20mm



Cod. 83035 Ruota in gomma gonfiabile / Inflatable rubber wheel

IT Diametro ruota: 220x75mm
Diametro foro: 25mm

EN Wheel diameter: 220x75mm
Hole diameter: 25mm

Filtri aria / Air filters



Cod. 84039-2 / **Filtro separatore / Air filter**

IT

Particelle: 5 micron
Efficienza: 95%
Drenaggio automatico

EN

Particles: 5 micron
Efficacy: 95%
Auto-draining



Cod. AW20-F02 / **Filtro regolatore / Air filter-regulator**

IT

Particelle: 5 micron
Efficienza: 95%
Drenaggio manuale

EN

Particles: 5 micron
Efficacy: 95%
Manual draining



Cod. M0107 / **Filtro aspirazione in spugna / Air intake foam filter**



Cod. 83045-1 / **Filtro aspirazione in carta / Air intake paper filter**

Pressostati / Pressure switches



Cod. 213635 / **CONDOR MDR1**

230/110 Volt – 50/60 Hz
F4-1/4



Cod. 226468 / **CONDOR MDR2**

230/110 Volt – 50/60 Hz
F4-1/4



Cod. 269991 / **CONDOR MDR3**

380 volt – 50/60 Hz
F4-3/8

Cod. 270003

230 volt – 50/60 Hz
F4-3/8



Cod. PM3VVRP7/9 / **NEMA 230**

230/110 volt – 50/60 Hz
F4-1/4



Cod. 83059 / **NEMA 380**

IT
230 volt - 50 Hz
C/TEMPORIZZATORE
F4-1/4

EN
230 volt - 50 Hz
W/TIMER
F4-1/4

Kit manutenzione / Maintenance Kits

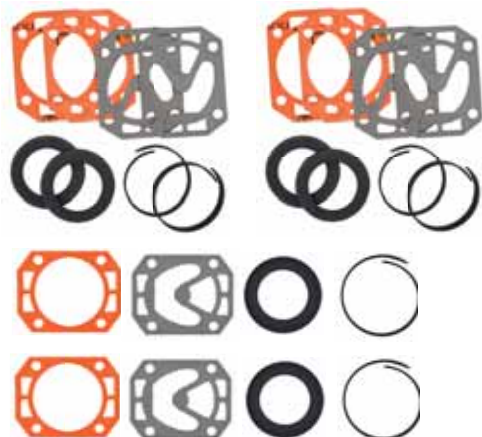

Cod. 86200

MOD. E480-E660-ES480

IT

- 4x Guarnizioni cilindro
- 4x Guarnizioni testate
- 4x Ring pistone in PTFE
- 4x Fascie di guida pistone in PTFE

EN

- 4x Cylinder gaskets
- 4x Cylinder head gaskets
- 4x PTFE piston rings
- 4x PTFE piston guide rings



Cod. 83200

MOD. C330-C240-CS240

IT

- 2x Guarnizioni cilindro
- 2x Guarnizioni testate
- 2x Ring pistone in PTFE
- 2x Fascie di guida pistone in PTFE

EN

- 2x Cylinder gaskets
- 2x Cylinder head gaskets
- 2x PTFE piston rings
- 2x PTFE piston guide rings



Cod. 87100

MOD. B110/ARIOSTO

IT

- 1x Guarnizione cilindro
- 1x Guarnizione testata
- 1x Ring pistone in PTFE

EN

- 1x Cylinder gasket
- 1x Cylinder head gasket
- 1x PTFE piston ring





GRUPPI POMPANTI
AIR PUMPS



▶ PROFESSIONALI A SECCO
OIL-FREE, HEAY-DUTY



MOD. B

MOD. B70 / B110

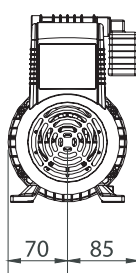
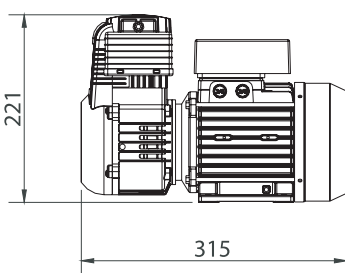
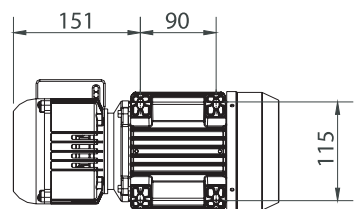
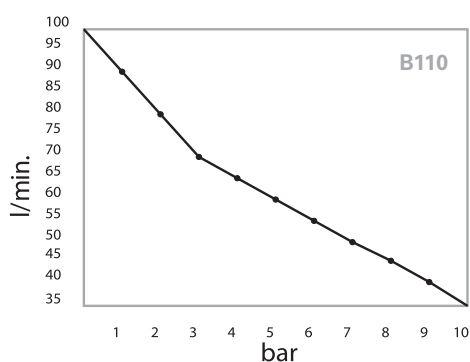
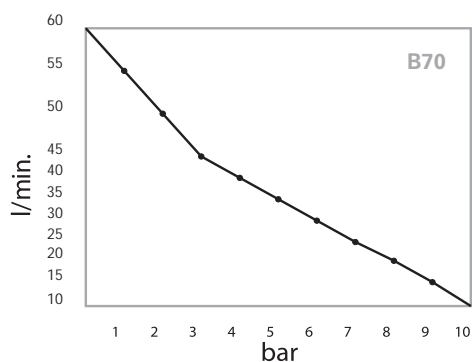

MOD. B



Modello	Potenza	Tensione	Giri	Cilindri	Classe	Pressione max	Aria aspirata	Aria resa (5 bar)	Rumore	Peso
<i>Model</i>	<i>Power</i>	<i>Voltage</i>	<i>RPM</i>	<i>Cylinders</i>	<i>Class</i>	<i>Max pressure</i>	<i>Air intake</i>	<i>Air yield</i>	<i>Noise</i>	<i>Weight</i>
	Kw	V/Hz/Na	rpm	n°		Bar	L/min	L/min	dB (A)	Kg
B70	0,75	230/50	1400	1	S1 - 100% ON	8	60	35	66	8,5
B110	0,5	230/50	2800	1	S3 - 70% ON	10	110	60	72	6,5

Su richiesta sono disponibili diversi voltaggi - *Different voltage available on request* 110v/60Hz - 110v/50Hz - 230v/60Hz

MOD. C

MOD. C240 / C330

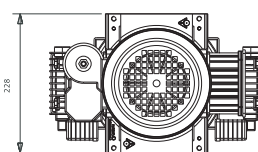
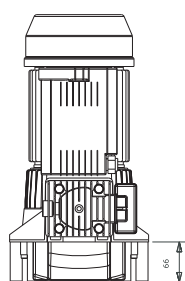
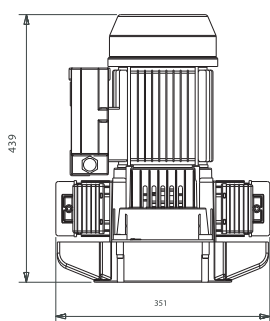
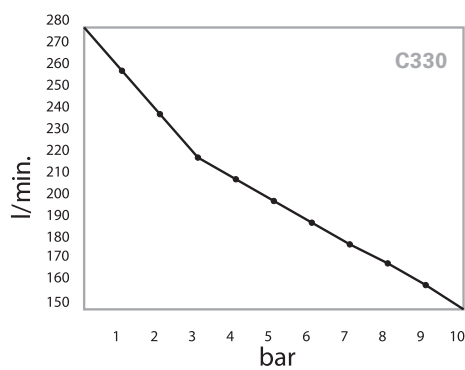
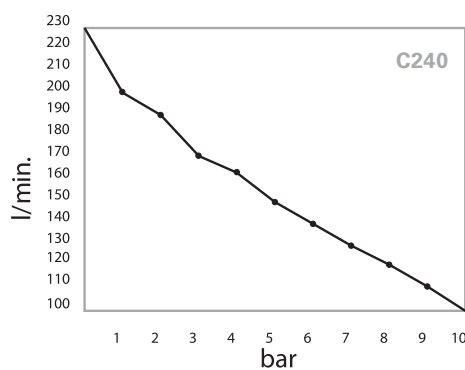

MOD. C



Modello	Potenza	Tensione	Giri	Cilindri	Classe	Pressione max	Aria aspirata	Aria resa (5 bar)	Rumore	Peso
<i>Model</i>	<i>Power</i>	<i>Voltage</i>	<i>RPM</i>	<i>Cylinders</i>	<i>Class</i>	<i>Max pressure</i>	<i>Air intake</i>	<i>Air yield</i>	<i>Noise</i>	<i>Weight</i>
	Kw	V/Hz/Va	rpm	n°		Bar	L/min	L/min	dB (A)	Kg
C240	1,5	230/50	1400	2	S1 - 100% ON	10	240	170	76	20
C330	1,7	230/50	1400	2	S1 - 100% ON	10	330	200	79	22

Su richiesta sono disponibili diversi voltaggi - Different voltage available on request 110v/60Hz - 110v/50Hz - 230v/60Hz

MOD. E

MOD. E480 / E660

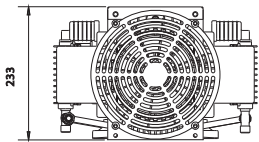
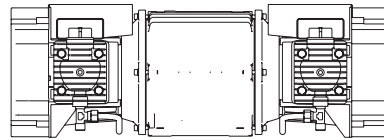
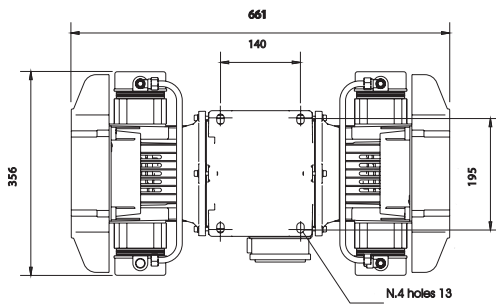
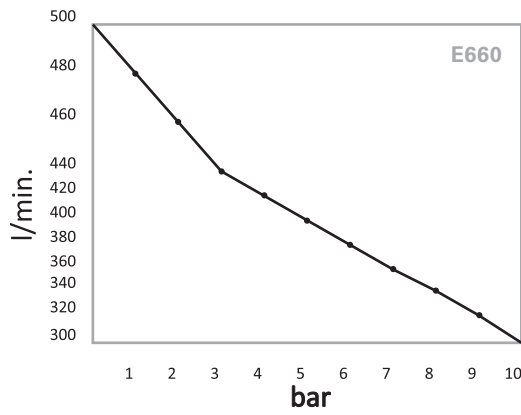
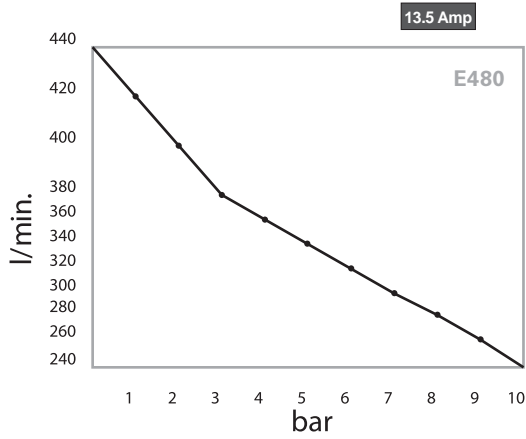

MOD. E



Modello	Potenza	Tensione	Giri	Cilindri	Classe	Pressione max	Aria aspirata	Aria resa (5 bar)	Rumore	Peso
<i>Model</i>	<i>Power</i>	<i>Voltage</i>	<i>RPM</i>	<i>Cylinders</i>	<i>Class</i>	<i>Max pressure</i>	<i>Air intake</i>	<i>Air yield</i>	<i>Noise</i>	<i>Weight</i>
	Kw	V/Hz/Va	rpm	n°		Bar	L/min	L/min	dB (A)	Kg
E480	3,2	230/50	1400	4	S1 - 100% ON	10	530	340	83	42
E660	3,4	380/50	1400	4	S1 - 100% ON	10	660	400	84	44

▶ PROFESSIONALI A SECCO SILENZIATI
OIL-FREE HEAVY-DUTY SILENCED



MOD. CS

MOD. CS120

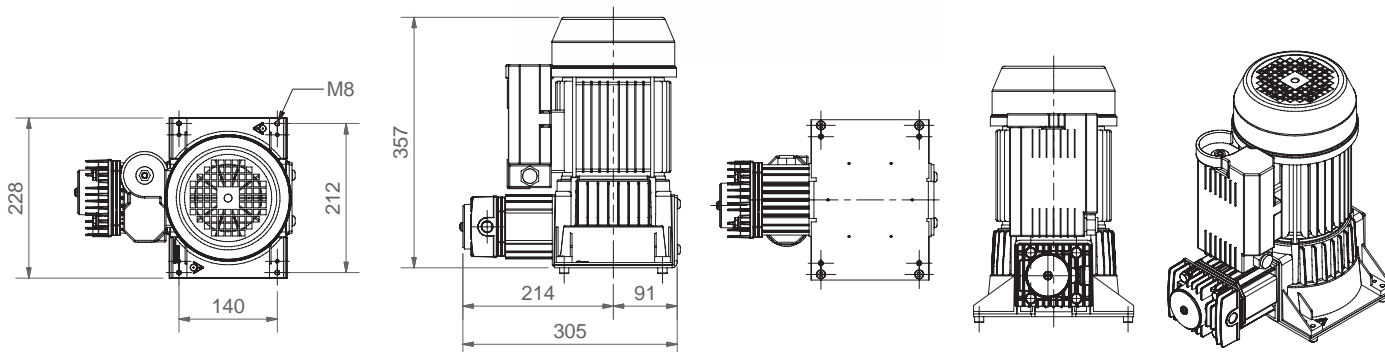
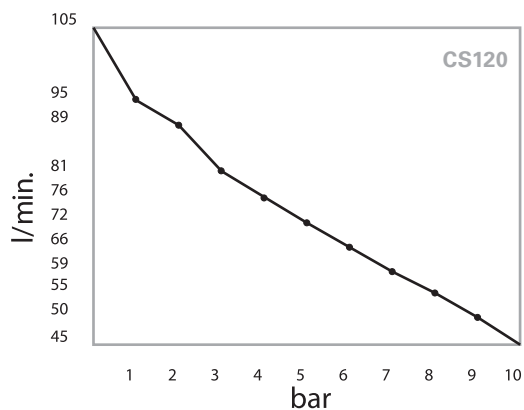

MOD. CS



Modello	Potenza	Tensione	Giri	Cilindri	Classe	Pressione max	Aria aspirata	Aria resa (5 bar)	Rumore	Peso
<i>Model</i>	<i>Power</i>	<i>Voltage</i>	<i>RPM</i>	<i>Cylinders</i>	<i>Class</i>	<i>Max pressure</i>	<i>Air intake</i>	<i>Air yield</i>	<i>Noise</i>	<i>Weight</i>
	Kw	V/Hz/Va	rpm	n°		Bar	L/min	L/min	dB (A)	Kg
CS120	0,75	230/50	1400	1	S3-70% ON	10	120	72	62	15

Su richiesta sono disponibili diversi voltaggi - Different voltage available on request 110v/60Hz - 110v/50Hz - 230v/60Hz

MOD. CS

MOD. CS240

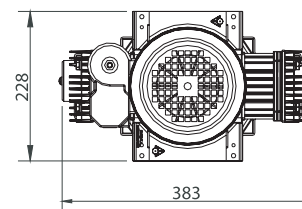
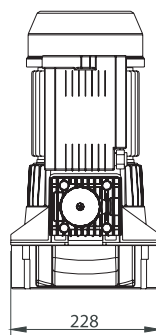
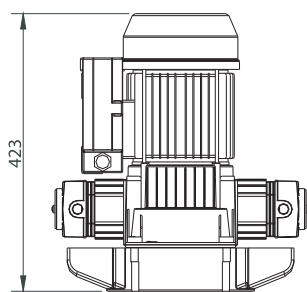
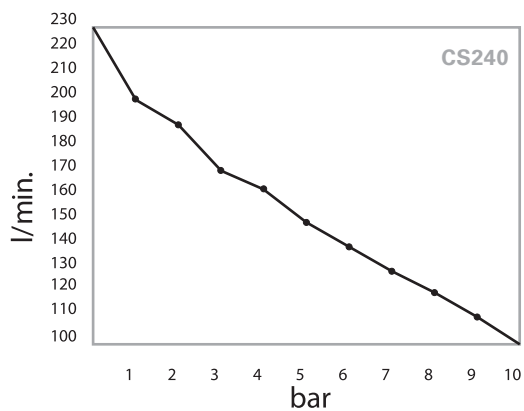

MOD. CS



Modello	Potenza	Tensione	Giri	Cilindri	Classe	Pressione max	Aria aspirata	Aria resa (5 bar)	Rumore	Peso
<i>Model</i>	<i>Power</i>	<i>Voltage</i>	<i>RPM</i>	<i>Cylinders</i>	<i>Class</i>	<i>Max pressure</i>	<i>Air intake</i>	<i>Air yield</i>	<i>Noise</i>	<i>Weight</i>
	Kw	V/Hz/Va	rpm	n°		Bar	L/min	L/min	dB (A)	Kg
CS240	1,5	230/50	1400	2	S1 - 100% ON	10	240	150	64	22

Su richiesta sono disponibili diversi voltaggi - Different voltage available on request 110v/60Hz - 110v/50Hz - 230v/60Hz

MOD. ES

MOD. ES480

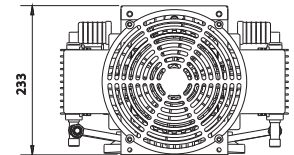
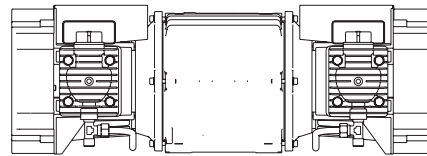
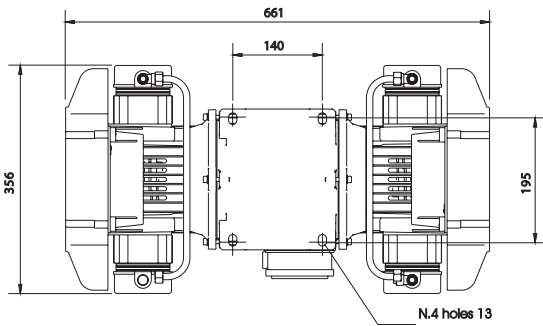
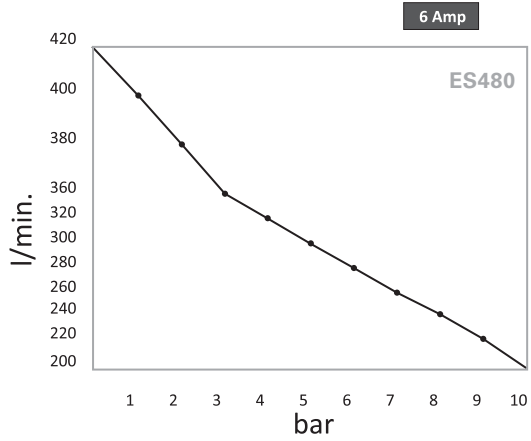

MOD. ES



Modello	Potenza	Tensione	Giri	Cilindri	Classe	Pressione max	Aria aspirata	Aria resa (5 bar)	Rumore	Peso
Model	Power	Voltage	RPM	Cylinders	Class	Max pressure	Air intake	Air yield	Noise	Weight
	Kw	V/Hz/Va	rpm	n°		Bar	L/min	L/min	dB (A)	Kg
ES480	3,4	380/50	1400	4	S1 - 100% ON	10	480	300	69	42

Su richiesta sono disponibili diversi voltaggi - Different voltage available on request 110v/60Hz - 110v/50Hz - 230v/60Hz



ROZA-GRAPI, SA

comercial@rozagrapi.com

*San Vicente Mártir, 20
Ana María, 47*

*28043 MADRID
33209 GIJON*

*Tif +34 914166614 / +34 914167626 Fax +34 915193075
Tif +34 985162833 Fax +34 985146622*

WWW.ROZAGRAPI.COM